



Characterization of  
particles • powders • pores

# cryoTune & cryoCooler

- ISO- and IUPAC-recommended adsorption isotherms using argon at 87 K
- Adjustable temperature range: 20–323 K
- Compatible with all common gas sorption analyzers



**Cryostatic Accessories  
for Sorption Analyzers**

# cryoTune & cryoCooler Overview

## The cryoTune as tool for gas sorption studies

Traditionally, nitrogen adsorption at the temperature of liquid nitrogen (approx 77.4 K) is used as the standard procedure. From a scientific point of view, however, argon and krypton are more suitable adsorptives for the surface and pore analysis of many materials (see also the norm ISO 9277 and the latest IUPAC recommendations in Pure Appl. Chem. 87 (2015) 1051). When compared to the  $N_2$  molecule, single atomic noble gases are spherically symmetrical. Consequently, the space requirement of adsorbed argon and krypton atoms is not influenced by the spatial orientation on the surface (see Fig. 1). Interactions between argon or krypton atoms and the solid surface are also less affected by the surface polarity, since the noble gas atoms do not have an electric quadrupole moment.

In addition, other adsorbents such as methane, ethane, propane, *n*-butane, oxygen, carbon dioxide,  $SF_6$ , etc. are used in different fields of science and industry. The cryoTune series requires only cost-effective liquid nitrogen for cooling and allows a temperature range for sorption measurements of 77 – 323 K (see Fig. 2). Furthermore, thermodynamic calculations can be performed at different temperatures.

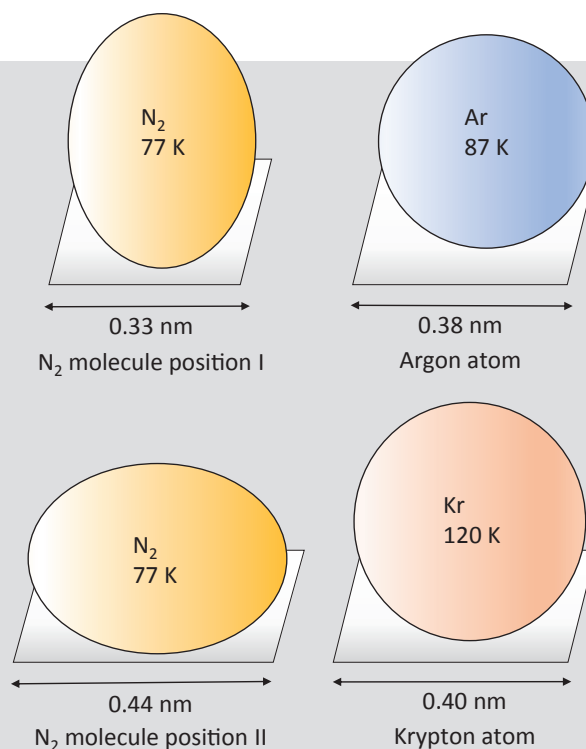

**Figure 1** Schematic comparison of the nitrogen molecule at 77 K with the noble gases argon 87 K and krypton 120 K. The nitrogen molecule can adsorb in different positions, whereas the spherical shape of the noble gas atoms allows only one position.

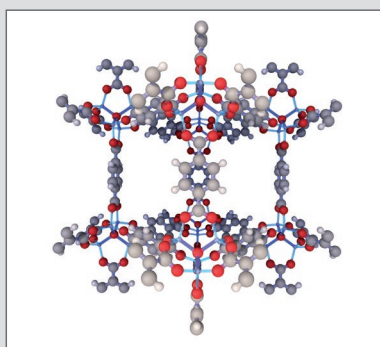

MOFs / Hybrid Materials



Activated Carbon

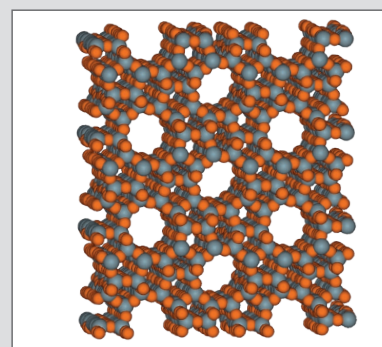

Zeolitic Materials



Material Research

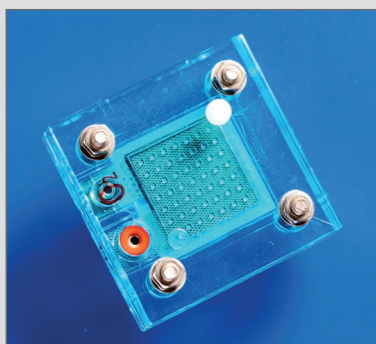

Batteries / Fuel Cells



Chemical Engineering

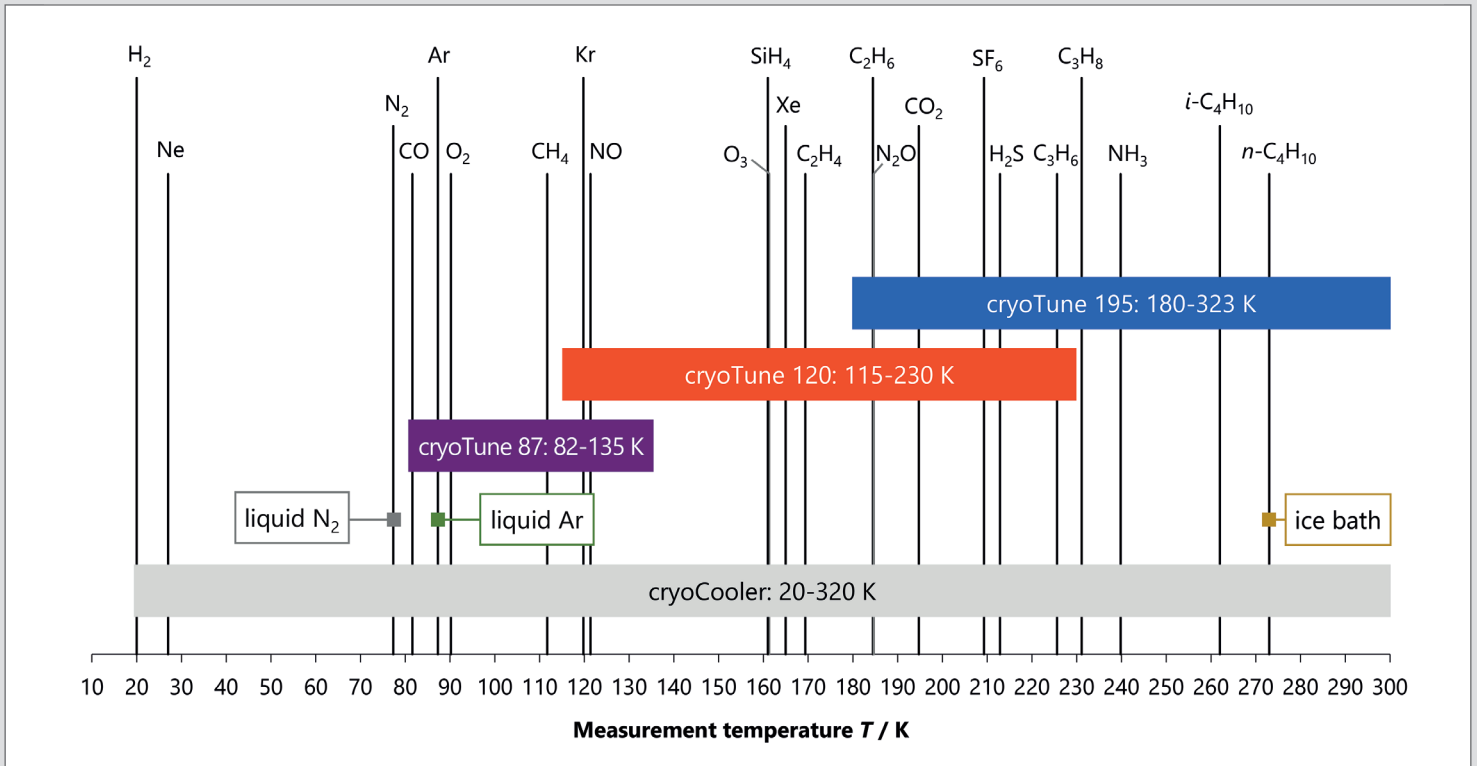

**Figure 2** Boiling points and possible measuring temperatures of various adsorptives including the measurement ranges of liquid nitrogen, the cryoCooler and the cryoTune

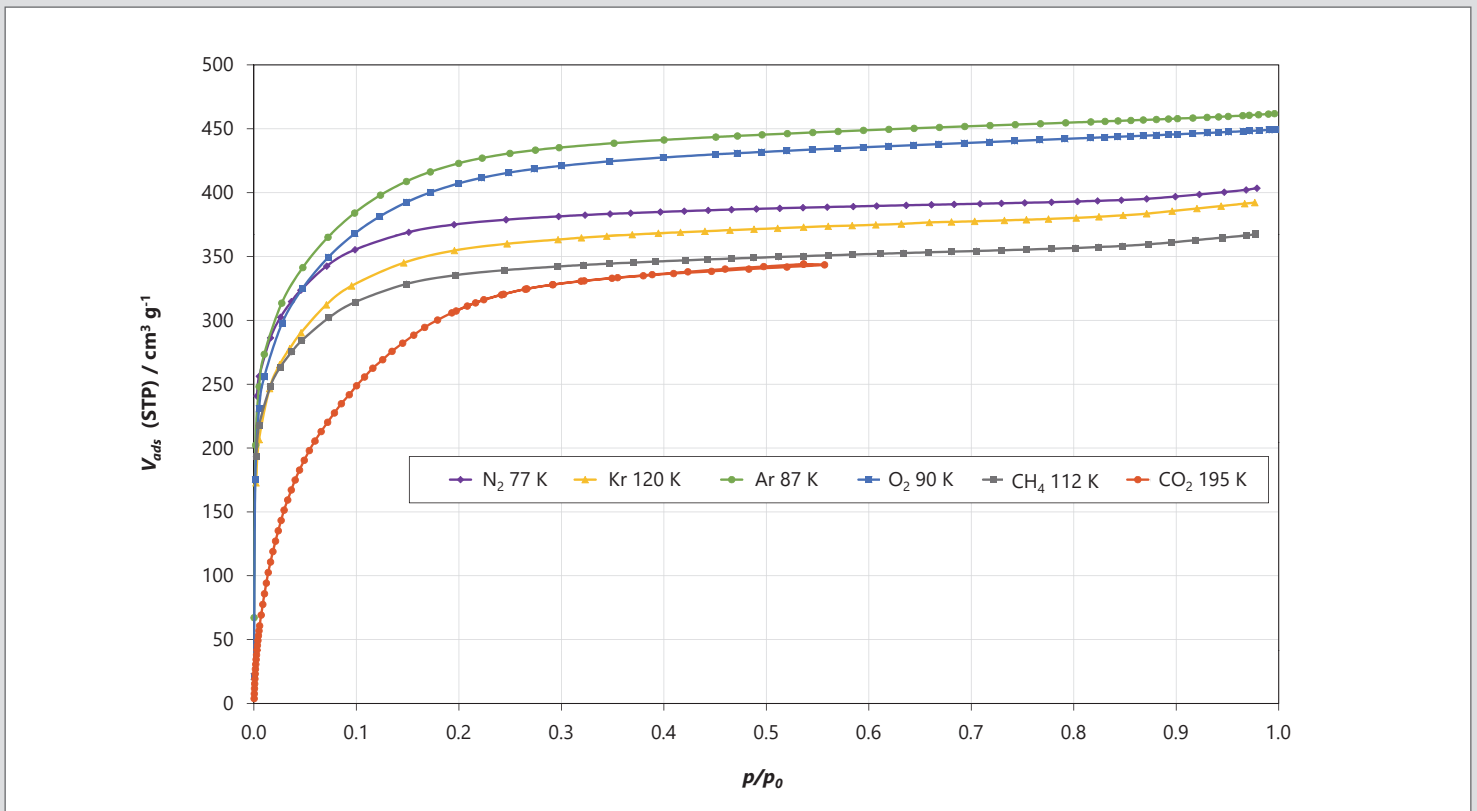

**Figure 3** Adsorption isotherms using various adsorptives (at their boiling temperatures) on a sample of activated carbon

# cryoTune & cryoCooler Features

## Features and Advantages of the cryoTune and cryoCooler

These accessories provide the experimental basis for sorption investigations and offer the following advantages:

### ■ Accurate

In contrast to boiling point temperature control, the temperature control of the measuring cell is independent of the ambient pressure. In addition, the cold zone of the measuring cell is reduced to a minimum and remains constant over the entire measuring period. The temperature stability is better than  $\pm 0.004$  K. The non-ideality of the used adsorptives at the measurement temperatures can be calculated.

### ■ Flexible

The cryoTune and cryoCooler can be used with all common sorption instruments and open a wide temperature measuring range that is otherwise difficult to access. If you would like to know whether your device is also supported, please contact us directly with your device configuration. The cryoTune can be easily handled and works noiselessly.

### ■ Economical

The cryoTune provides a cost-effective substitution of expensive liquid gases by the economical and efficient consumption of low-cost liquid nitrogen for cooling. Whereas the cryoCooler enables measurements below 77 K without a cryogen, the cryoTune is an option for the temperature range 82-323 K with a significantly better price-performance ratio.

### ■ Ecological

The cryoTune series can be used over a broad temperature range. However, a cryoCooler is necessary for adsorption studies of hydrogen at its boiling point of 20 K or other applications below 77 K. The cryoTune has a lower energy consumption and requires less lab space compared to the cryoCooler.

## Possibilities

- ISO- and IUPAC-recommended adsorption isotherms using argon at 87 K
- Adjustable temperature range: 20 – 323 K
- Compatible with all common gas sorption analyzers
- Isotherms of other adsorptives at their boiling temperatures (e.g. krypton, methane, ethane, propane, *n*-butane, oxygen, carbon dioxide, or sulfur hexafluoride)
- BET surface area and micropore analysis using noble gases
- Thermodynamic calculations at different temperatures

## Functionality of the cryoTune

Inside the cryoTune, the measuring cell for temperature control is not directly immersed in liquid nitrogen, but is located in a heat conducting block that can be heated close to the sample and allows heat transfer between measuring cell and liquid nitrogen. Through controlled heating, a temperature range above the boiling point of nitrogen as the measuring temperature can be precisely set and thus different temperatures can be maintained.

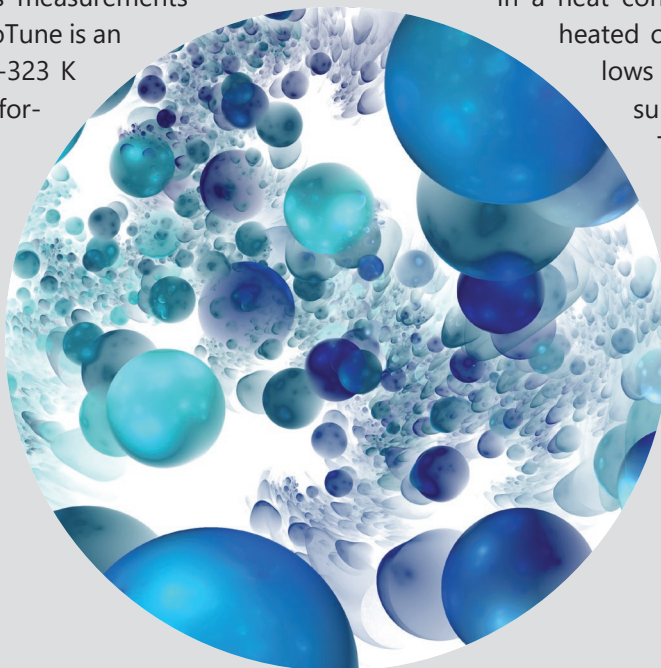

## The role of the temperature transition zone for gas sorption measurements

Different principles are known to realize a constant level of coolant in a dewar during a measurement. Some advantages and disadvantages of the main principles are given in Tab. 1.

The cryoTune-principle prevents the mentioned disadvantages, because

- it realizes a constant temperature transition zone independent of the measuring temperature;
- it ensures that the sample cell is situated in a short cold zone of few centimeters (see Fig. 4): such a minimization of the cold free-space becomes relevant for measurements of materials with small surface areas;
- it does not change the position of the dewar during the measurement and therefore, the temperature transition zone remains constant.

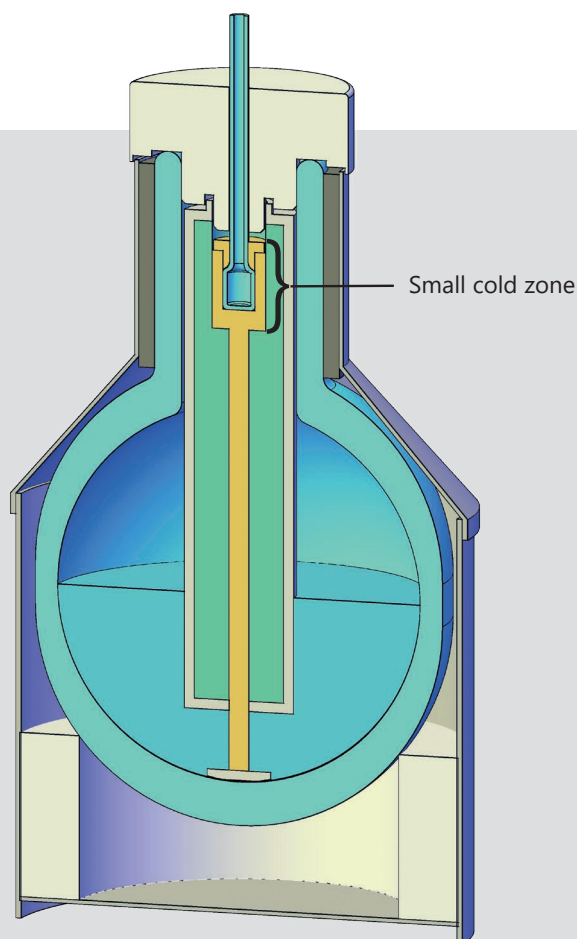

**Figure 4** Scheme of the cryoTune with highlighted small cold zone

**Table 1** Principles of temperature transition zone control in gas sorption analyzers

Principles of temperature transition zone control in gas sorption analyzers	Volume of cold free-space at cryogenic temperature	Temperature transition zone during the measurement
cryoTune principle	Small	Constant
Isothermal jackets	Large	Constant
"Level sensor principle"	Small	Changing temperature transition zone due to moving dewar, error depends on the gas amount in temperature transition zone
Additional correction tube	Large at the beginning, changing during the measurement	Changing, corrected by the use of the additional tube

# cryoTune Handling & Software

## cryoTune handling & software use

The robust design of the cryoTune prevents cable damaging and moisture penetration. Changing of the measuring cells during operation is easily done by using the splittable PTFE cover. A little hole in the cover enables refilling of liquid nitrogen during long-term measurements. This hole is covered during the measurement to optimize the dewar holding time. The special geometry of the cryogenic unit prevents liquid nitrogen from penetrating directly into the measuring chamber of the cryoTune.



**Figure 5** The use of a cryoTune: the cryoTune is placed inside the dewar (1). The sample cell is then placed into the cryoTune (2). Finally, the dewar is closed with the special isolation cover (3).

The use of one but also of up to three cryoTunes units in combination with a multiport sorption analyzer is easy to handle. The adaptation of the display colors in the software and in parallel at the controller display is very helpful for easy assignment of the cryoTune units. And, as seen in Fig. 6, the controllers on the top of the analyzer and the cryo-units inside the dewars do not need additional lab space.

Although a cryoTune can work as stand-alone without a PC, it is delivered with software that displays and records the real-time temperature as well as the remaining measuring time with the actual nitrogen filling (Fig. 7). The software is multilingual, currently supports three temperature units, seven pressure units, and calibration with 22 measuring gases and is very intuitive to use. The software can control up to three cryoTunes simultaneously. The cryoTunes can be connected to each other with short USB cables, so that only a long USB cable needs to be connected to the computer.



**Figure 6** Three different gases on three different ports: the cryoTunes 195, 120 and 87 on a 3P micro 300 micropore analyzer



**Figure 7** The cryoTune software displays and records the real-time temperature as well as the remaining measuring time with the actual nitrogen filling

## cryCooler for measurements below 77 K

Only few adsorptives - respectively gas sorption applications - need adsorption measurements at temperatures below 77 K. Two examples are hydrogen adsorption at its boiling temperature (20 K) and neon at its boiling temperature (27 K). The cryCooler enables the cryogen free temperature control in a temperature range of < 20 K – 320 K with an infinite holding time and consists of a compressor and other parts. One cryCooler can temper up to 3 measuring cells (see Fig. 8), i.e. up to three hydrogen or neon isotherms can be measured in one cooling unit.

Both the cryCooler and the cryTune enable an exact measurement of, e.g. Ar at 87.4 K without the liquid adsorbent as coolant (see Fig. 9).



**Figure 8** The cold head of the cryCooler with ports for up to three measuring cells

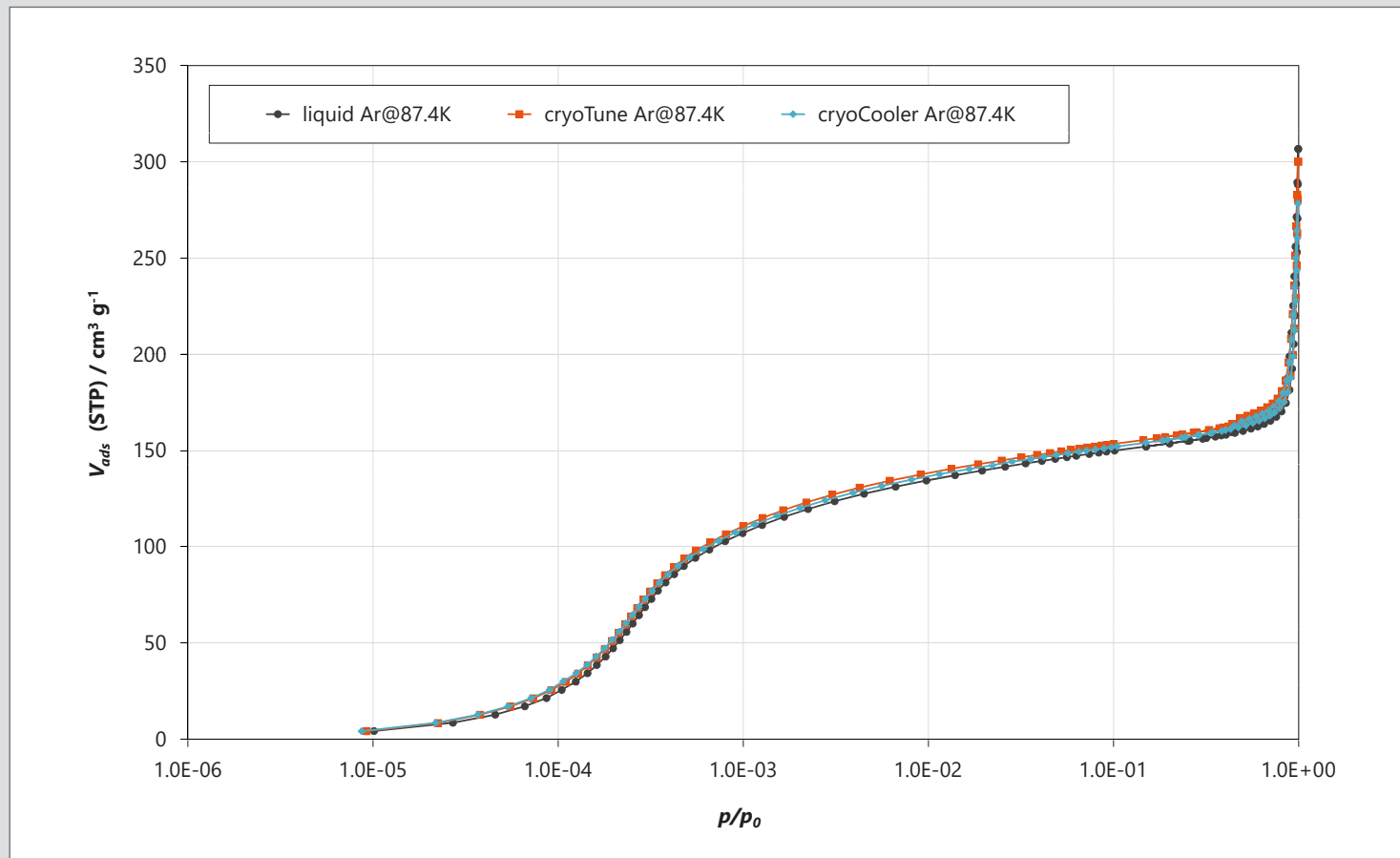

**Figure 9** Overlay of three isotherms recorded on Zeolite 13X: Ar 87.4 K measurements using liquid argon as coolant in comparison to the cryogen-free temperature controllers cryTune and cryCooler

# Your partner in particle characterization

3P Instruments has over 30 years of profound expertise in the characterization of particles, powders and pores

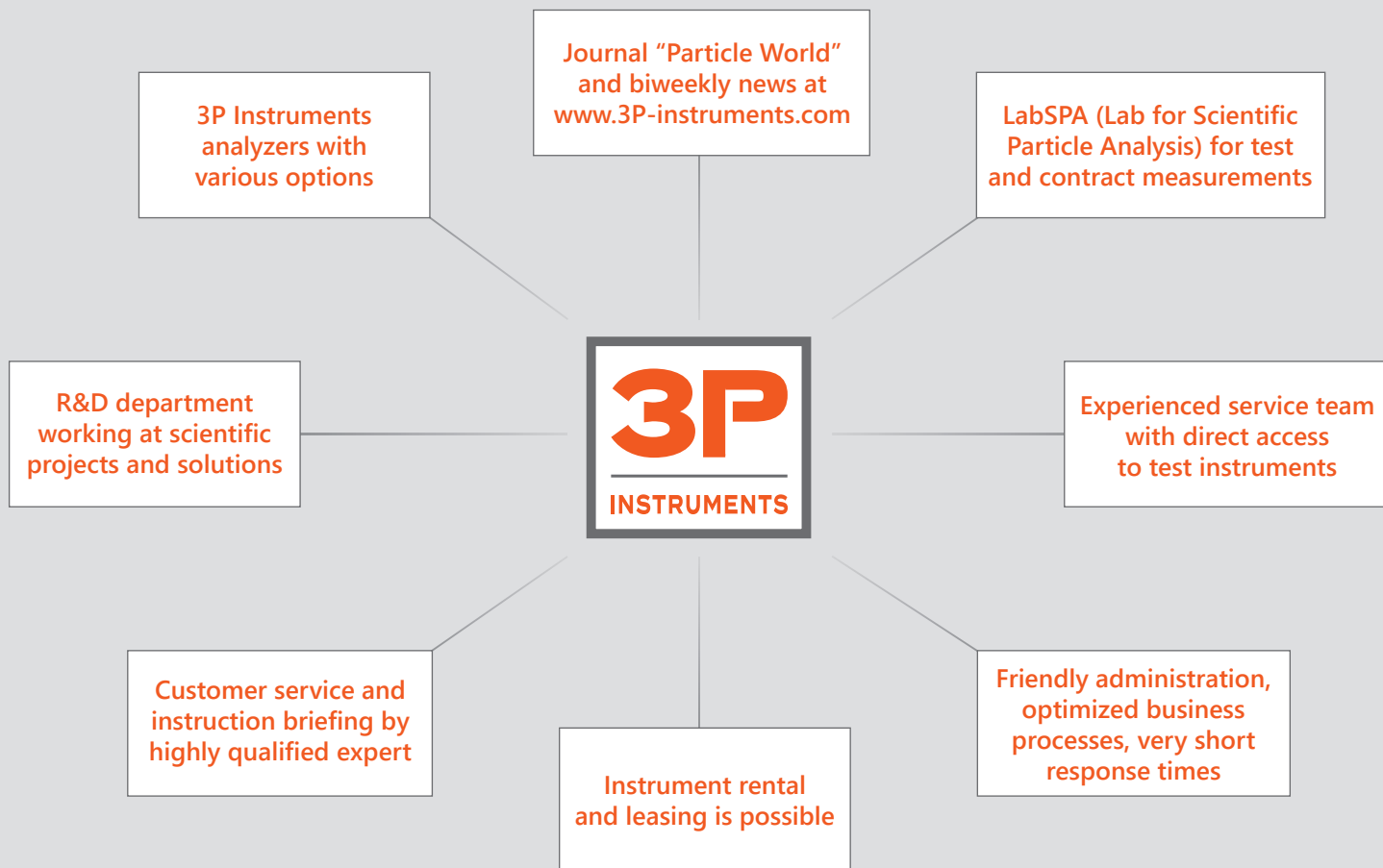

## Interested in scientific studies using the cryoTune?

Our yellow paper called „Adsorption studies of porous and nonporous materials with various adsorptives in the entire temperature range from 77 K up to 323 K“ is available free of charge!

Order now: [info@3P-instruments.com](mailto:info@3P-instruments.com) or +49 8134 9324 0



3P Instruments GmbH & Co. KG  
Rudolf-Diesel-Str. 12  
85235 Odelzhausen | Germany

Tel. +49 8134 9324 0  
[info@3P-instruments.com](mailto:info@3P-instruments.com)  
[www.3P-instruments.com](http://www.3P-instruments.com)