

3P Surface Area and Porosity Analyzers



- BET Surface Area
- Pore Size Distribution
- Pore Volume

- Adsorption Capacity
- Chemisorption Parameters
- Vapor Sorption

- Heat of Adsorption
- Research and Development
- Quality Control

STATIC-VOLUMETRIC AND DYNAMIC GAS ADSORPTION ANALYZERS

PARTICLE CHARACTERIZATION

POWDER ANALYSIS

PORE DETERMINATION



Characterization of
particles • powders • pores

info@3P-instruments.com
www.3P-instruments.com

Contents

Overview 2

3P micro series 4
Up to three independent analysis ports for high-performance physical adsorption experiments of microporous materials, such as active carbon, zeolites, MOFs, etc

3P meso series 7
Up to four independent analysis ports for the determination of meso and macro pores from 2 up to 500 nm

3P sync series 10
Sorption analyzer with up to four measuring stations in one dewar: high sample throughput with small lab space requirement, combined with minimum liquid nitrogen consumption

3P surface DX 13
Fully automated dynamic single- and multi-point sorption analyzer with reference mode for fast BET measurements

Optional Accessories and Tools 15
External degasser, additional vapor source, cryostatic accessories and our simulation software for dynamic experiments or mixed gas experiments

MixSorb series 17
For mixed gas/vapor adsorption



Applications

- Research and Development
- Quality Control
- Zeolites, MOFs, active carbon, silica gels, ...
- Determination of BET surface area
- Analysis of Pore Size Distribution and Pore Volume
- Determination of Chemisorption Parameters
- Vapor Sorption Measurements
- Determination of Adsorption Capacity and Heat of Adsorption

Introduction

For 30 years, 3P Instruments has been standing for methods of the characterization of particles, powders and porous materials in Europe. The purpose of the department "Surfaces & Pores" is to offer professional consultation and scientific solutions concerning our analytical instruments and methods to customers in the fields of research, development, or quality control of powders and porous materials. We are mainly focused on the determination and evaluation of characteristics such as the BET surface area, pore size distribution, porosity, pore volume, adsorption capacity, chemisorption parameters, breakthrough analysis, mixed gas adsorption, density, and permeability.

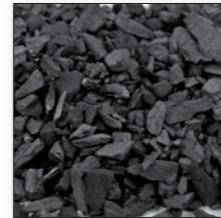
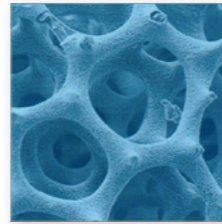

3P Gas Adsorption Analyzer Series

The characterization of surface areas and pores of solid materials are important parameters in many laboratories and are usually determined by gas adsorption equipment. These techniques can be complemented by adsorption of water and other vapors, chemisorption, high-pressure- and breakthrough measurements. 3P Instruments offers a broad range of different surface area and pore size analyzers, perfectly designed to meet your application requirements in terms of analysis parameters, flexibility, desired sample throughput, ease of use and analysis speed. This brochure gives an overview of our instrument models and possible configurations.

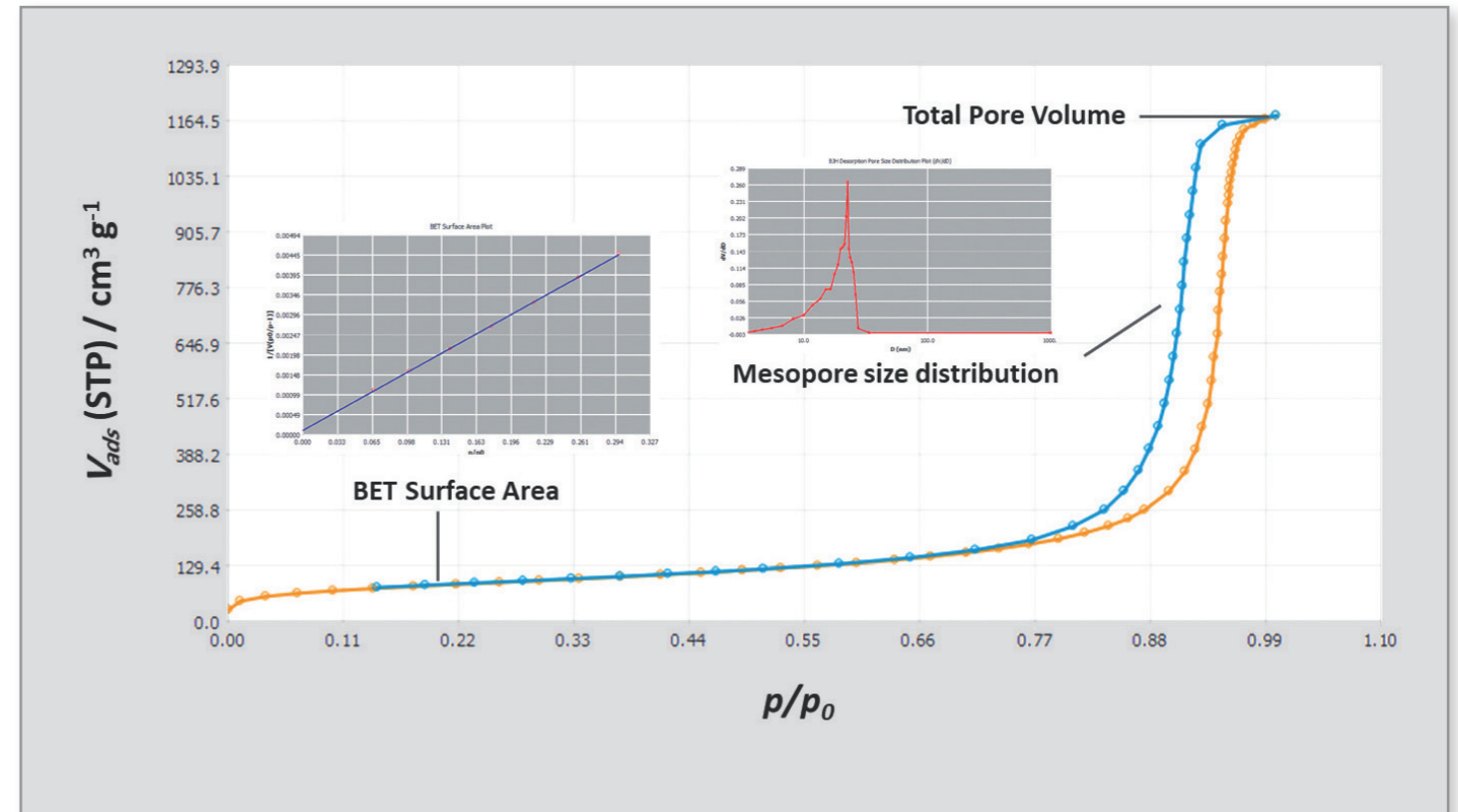
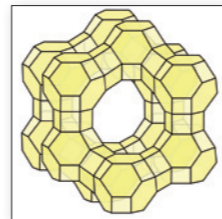

Example: Mesopore Analysis

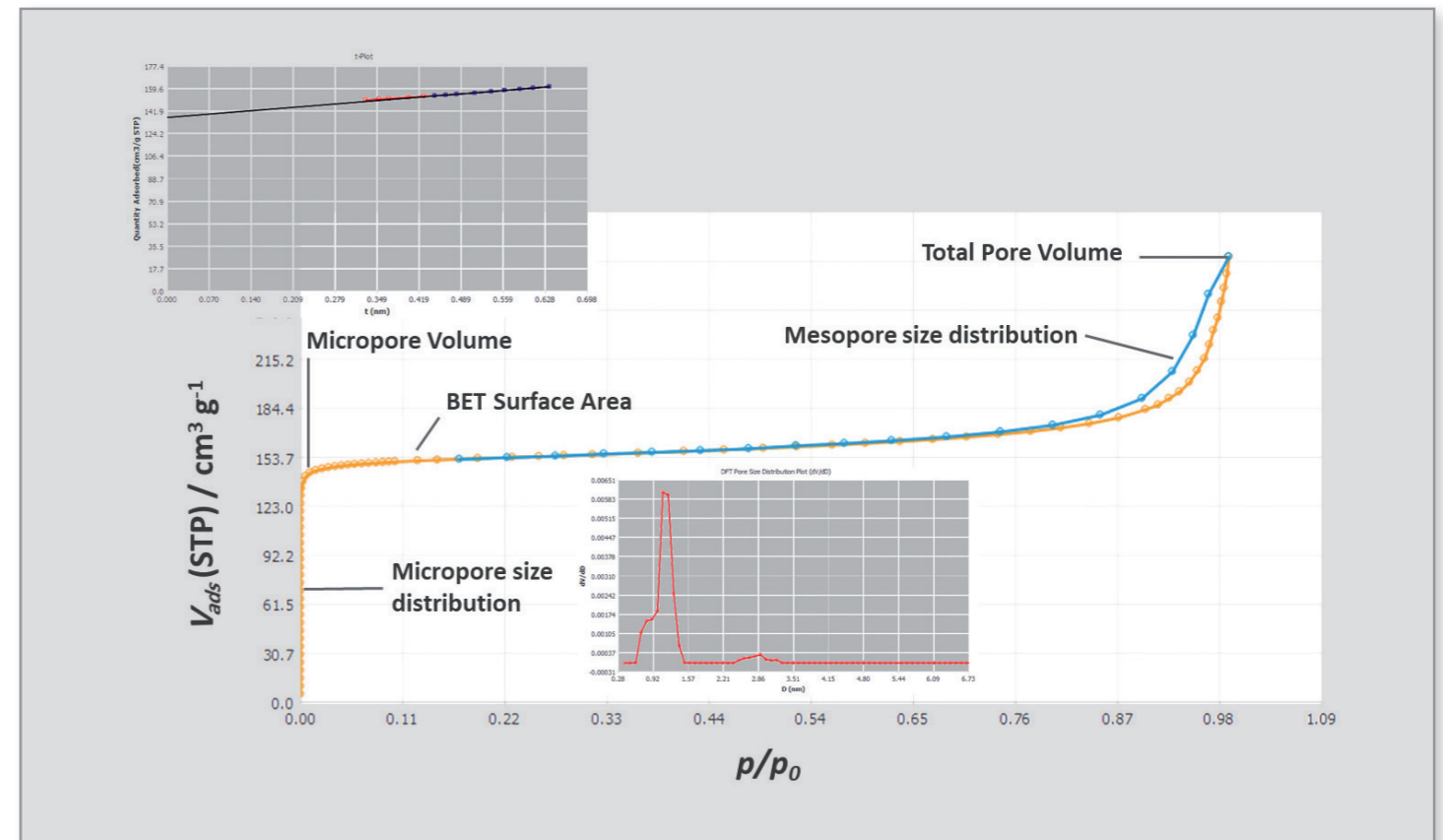

Example: Micropore Analysis

3P micro series



The 3P micro series enables high-performance physical adsorption experiments of microporous materials, such as activated carbon, zeolites, MOFs and similar materials. Due to the different needs of sample throughput and analysis conditions, the instruments can be equipped with one, two, or three completely independent analysis ports. Each port has an independent manifold containing a set of 1000; 10; and 1 (or 0.1) Torr transducers; an independent p_0 transducer; and an individual Dewar or other coolant device. As each analysis port acts completely independent, there is no time loss, regardless if one, two, or three analyses are started at the same time or if another measurement is started while others are already running.

Applicable methods and determinable parameters

- Isothermal adsorption and desorption curve
- BET specific surface area (single point, multi-point)
- Langmuir surface area
- External surface area (STSA)
- BJH pore size analysis
- t-plot analysis
- DR, DA, MP method
- HK pore size analysis
- SF pore size analysis
- NLDFT pore size distribution
- Pore size mode, average pore size, total pore volume
- Calculation of heat of adsorption, etc.

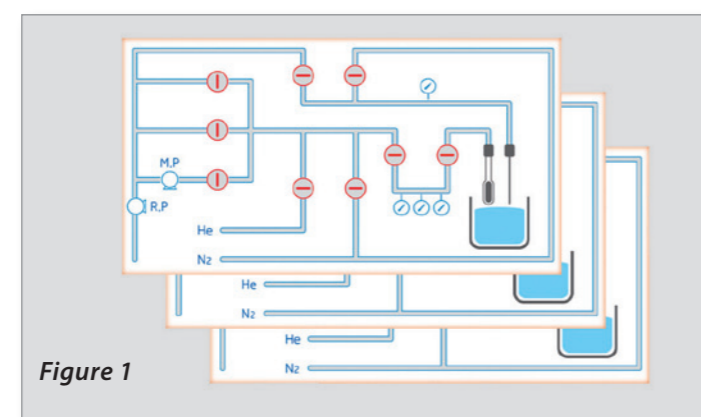

Figure 1

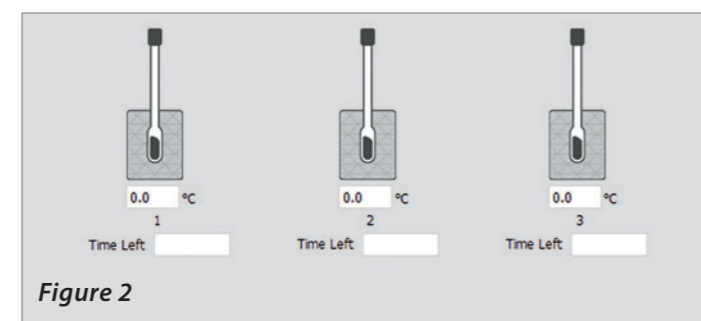

Figure 2

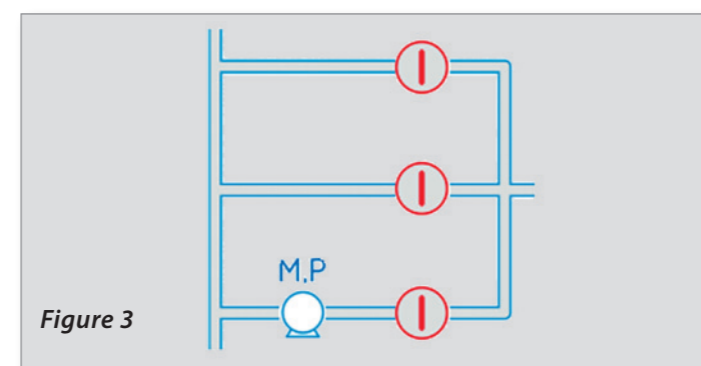

Figure 3

Benefits and Features

- The 3P micro series is available with one, two or three **independent measurement station(s)** for high resolution sorption measurement(s) and includes a turbo molecular pump.
- Each measurement station has **its own set of pressure transducers** (1000, 10 and 1 Torr (optional 0.1 Torr)), and includes also a 1000 Torr p_0 transducer.
- Each measurement station has its **own gas input**. The system can run up to three different experiments at different temperatures and different gases simultaneously (Figure 1).
- **Software driven, fully programmable in-situ degassing** at each station. Additional degassers are optional (Figure 2).
- **Three-step evacuation routine** for safe sample handling including very fine particles and highly porous materials (Figure 3).
- Presentation of **real-time kinetic data (pressure versus time)** to check and visualize equilibrium conditions (Figure 4).
- 3P Instruments offers **state-of-the-art data reduction**: all common and new data reduction models (SF, Monte Carlo Simulation, DFT with a recently developed kernel library) are available for calculations and are integrated in the MS Windows based software.
- **Density Measurement** via an optional pycnometry function.
- **Two step filter system** to protect the system against sample contamination.
- Change of dose amounts and equilibration settings **on-the-fly**, a restart of the analysis is not necessary (Figure 5).

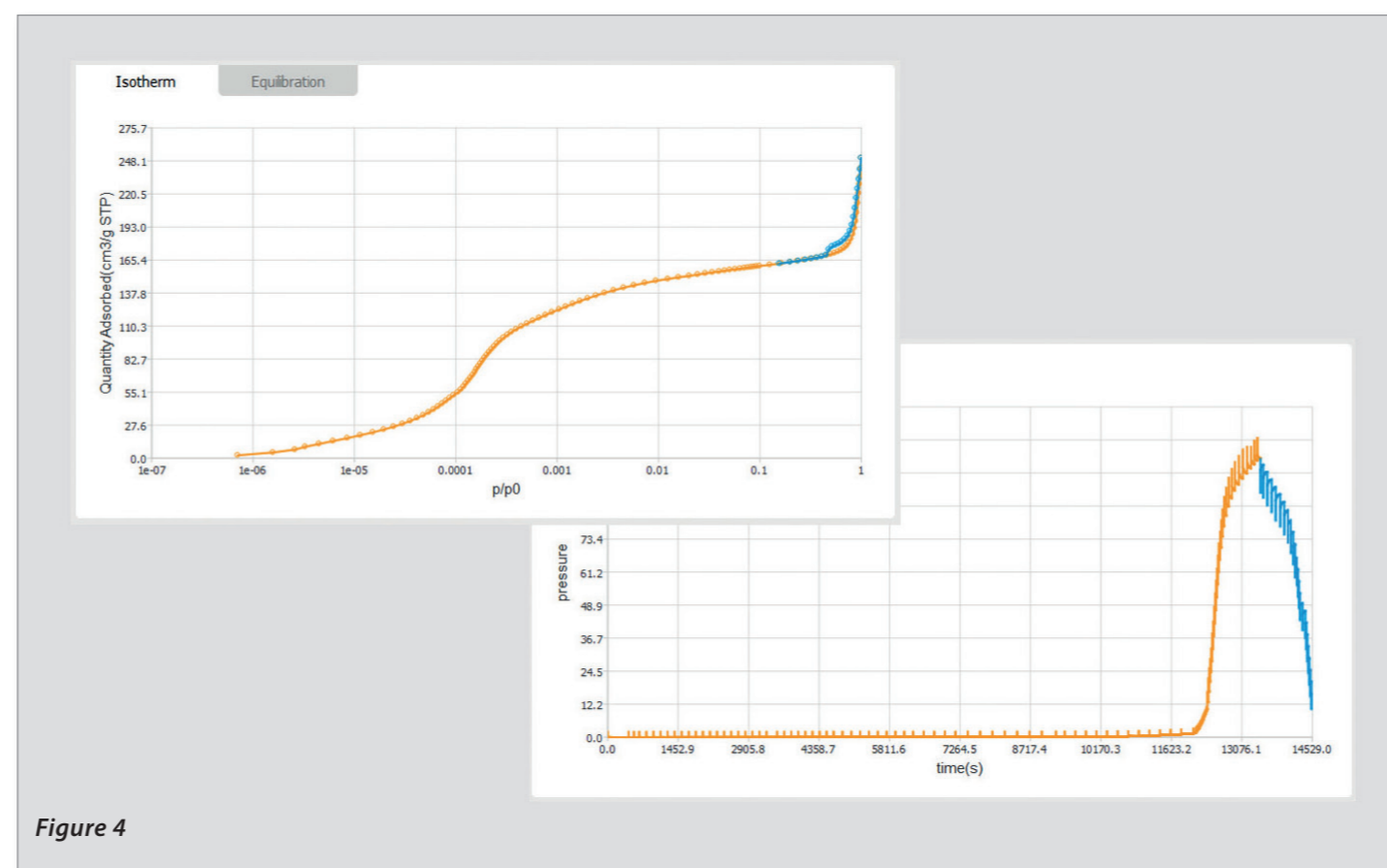

Figure 4

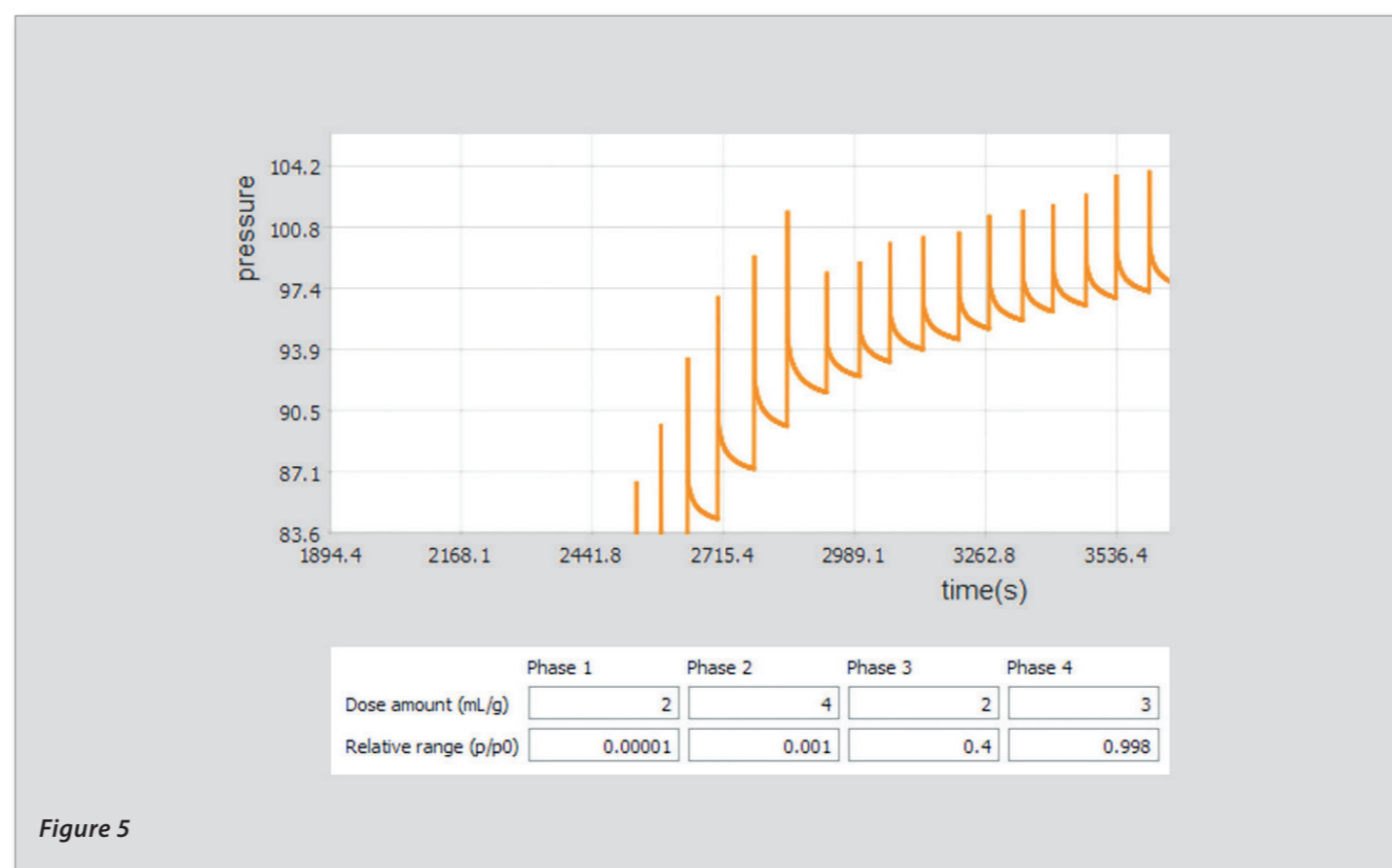

Figure 5

Specifications

Type	3P micro 100	3P micro 200	3P micro 300
Test Principle	Gas adsorption by static volumetric method		
Adsorbates	N ₂ , Ar, Kr, H ₂ , O ₂ , CO ₂ , CO, NH ₃ , CH ₄ , etc.		
Analysis Port(s)	1	2	3
p_0 Port(s)	1	2	3
Surface Area Range	0.0001 m ² /g to unknown upper limit; Measurement accuracy (standard sample) $\leq \pm 1.0 \%$		
Pore Size Range	0.35 nm – 500 nm Repeatability: ≤ 0.2 nm in mesopore range and ≤ 0.02 nm in micropore range		
Minimum Pore Volume	0.0001 cm ³ /g		
Pressure Sensors (per Analysis Station)	1000 Torr, 10 Torr and 1 Torr (C1 version) or 0.1 Torr (C version), one extra 1000 Torr for p_0 determination		
Pressure Sensor Accuracy	$\pm 0.15 \%$ (Full Scale)		
Range of Relative Pressure p/p_0	10^{-8} – 0.998		
Degassing Stations	1 in-situ, 2 extra	2 in-situ, 2 extra	3 in-situ
Degassing Temperature	Room temperature to 400 °C (optional 500 °C), accuracy 1 °C		
Vacuum System	Turbo molecular pump (ultimate vacuum 10^{-8} Pa) plus front mechanical vacuum pump (ultimate vacuum $6.7 \cdot 10^{-2}$ Pa)		
Dimensions	L 700 x W 700 x H 850 mm, Weight 80 – 90 kg		
Temperature Requirements of Environment	15 – 40 °C		
Humidity Requirements of Environment	10 % – 90 %		
Power Requirements	AC 220 V \pm 20 V, 50/60 Hz, maximum power 300 W, current 5 A		

3P meso series



The 3P meso series follows the principle of independent analysis ports for the determination of meso and macro pores from 2 up to 500 nm. One, two, and four port systems are available to optimally meet the customers demands. Designed for the field of quality assurance and/or production control, these analyzers provide an independent dosing manifold equipped with 1000 Torr transducers for each measurement port. Each of the measurement stations include the capability to degas the sample in-situ (up to 400 °C). This principle avoids sample contamination during sample transfer from separate degassers to the analysis port without taking any further precautions. However, for materials where these effects are insignificant, external degassers are available as well.

Applicable methods and determinable parameters

- Isothermal adsorption and desorption curve
- BET specific surface area (single point, multi-point)
- Langmuir surface area
- External surface area (STSA)
- BJH pore size analysis
- t-plot analysis
- DR, DA, MP method
- HK pore size analysis
- SF pore size analysis
- NLDFT pore size distribution
- Pore size mode, average pore size, total pore volume
- Calculation of heat of adsorption, etc.

Benefits and Features

- The 3P meso series is available with one, two, or four **independent measurement station(s)** for high-resolution sorption measurement(s).
- Each measurement station has its own set of **pressure transducers** and each includes its own 1000 Torr p_0 transducer.
- Each measurement station has its **own gas input**. The system can run up to four different experiments at distinct temperatures and various gases simultaneously (Figure 1).
- **Software driven, fully programmable in-situ degassing** at each station. Additional degassers are optional (Figure 2).
- **Three step evacuation routine** for safe sample handling including very fine particles and high porous materials (Figure 3).
- Presentation of **real-time kinetic data (pressure versus time)** to check and visualize equilibrium conditions (Figure 4, see next page).
- **Density Measurement** via an optional pycnometry function.
- **Two step filter system** to protect the system against sample contamination.
- Change of dose amounts and equilibration settings **on-the-fly**, a restart of the analysis is not necessary (Figure 5, see next page).

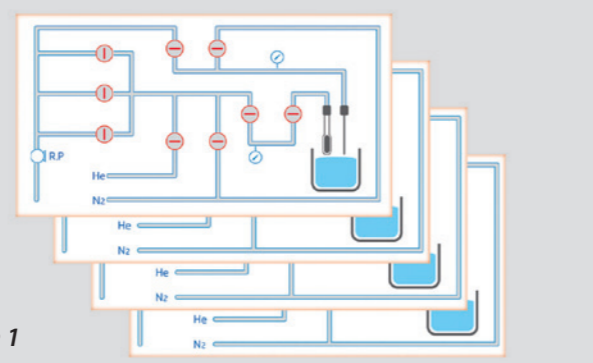

Figure 1

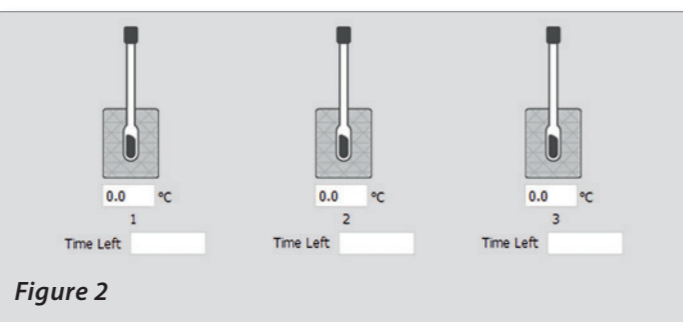

Figure 2

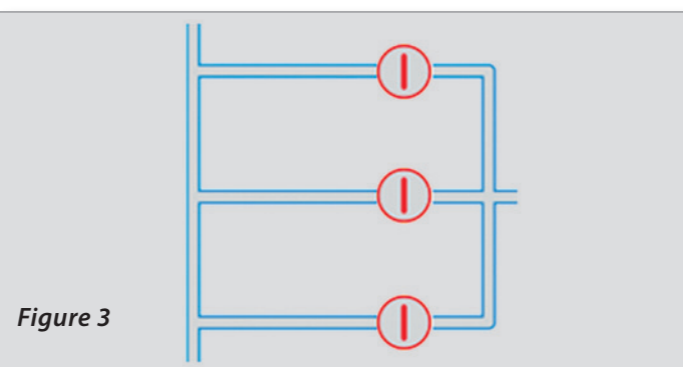

Figure 3

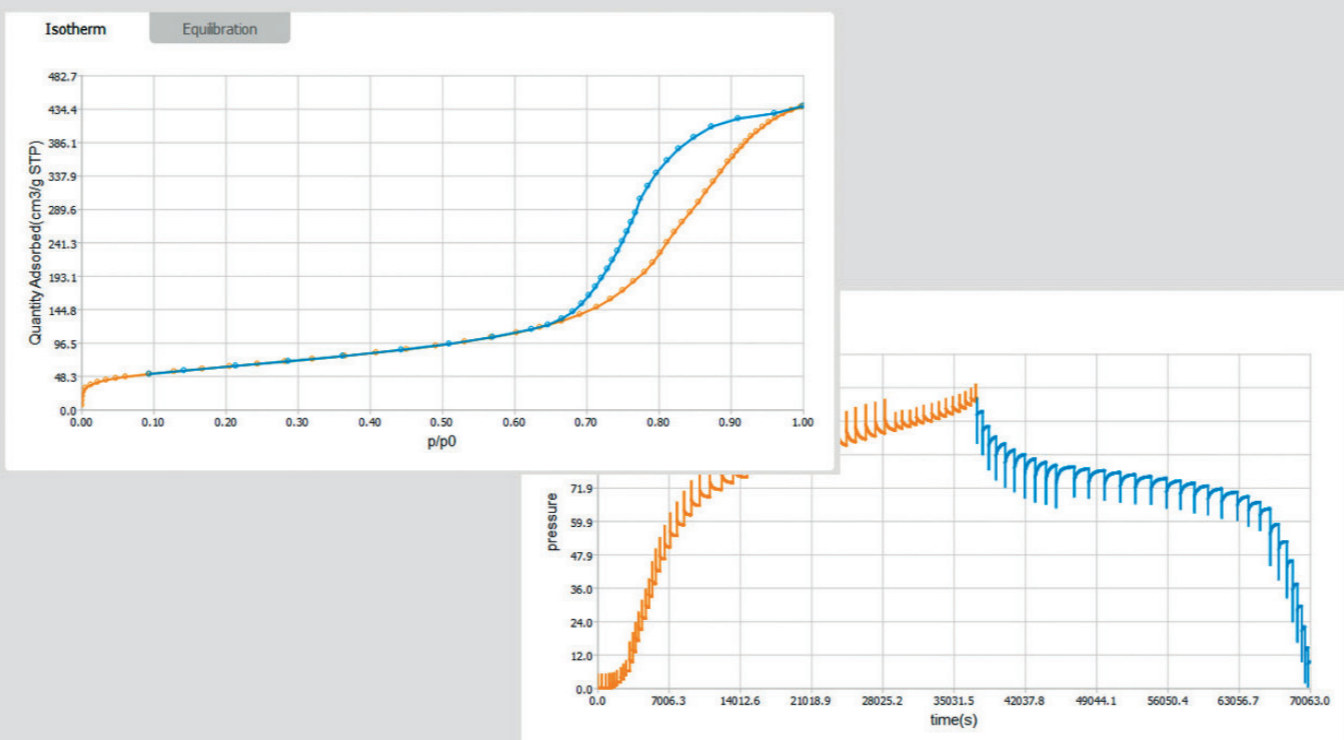

Figure 4

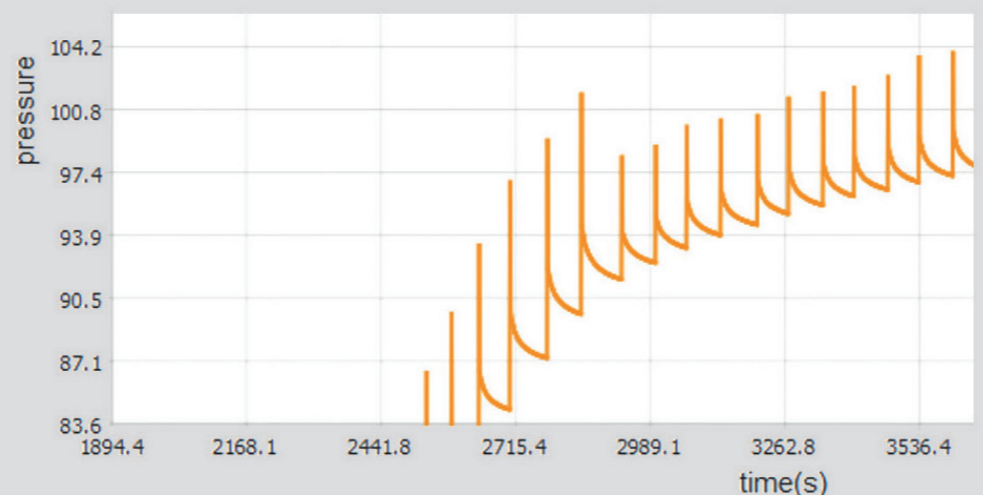

Figure 5

Specifications

Type	3P meso 112	3P meso 222	3P meso 400
Test Principle	Gas adsorption by static volumetric method		
Adsorbates	N ₂ , Ar, Kr, H ₂ , O ₂ , CO ₂ , CO, NH ₃ , CH ₄ , etc.		
Analysis Port(s)	1	2	4
p_0 Port(s)	1	2	4
Measurement Transducers	1	2	4
p_0 Transducers	1	2	4
Surface Area Range	0.0005 m ² /g to unknown upper limit; Measurement accuracy (standard sample) ≤ ± 1.0 %		
Pore Size Range	0.35 nm – 500 nm		
Minimum Pore Volume	0.0001 cm ³ /g		
Pressure Sensor Accuracy	± 0.15 % (Full Scale)		
Range of Relative Pressure p/p_0	10 ⁻⁴ – 0.998		
Degassing Stations	2 in-situ	2 in-situ	4 in-situ
Degassing Temperature	Room temperature to 400 °C (optional 500 °C), accuracy: 1 °C		
Vacuum System	Mechanical vacuum pump (ultimate vacuum 6.7*10 ⁻² Pa)		
Dimensions	L 740 x W 500 x H 940 mm	L 740 x W 500 x H 940 mm	L 840 W x 630 x H 940 mm
Weight	75 kg	75 kg	85 kg
Temperature Requirements of Environment	15 – 40 °C		
Humidity Requirements of Environment	10 % – 90 %		
Power Requirements	AC 220 V ± 20 V, 50/60 Hz, maximum power 300 W, current 5 A		

3P sync series



With the 3P sync series, 3P Instruments now offers new measuring instruments with up to four measuring stations and a separate p_0 measuring cell for simultaneous measurement of the saturation vapor pressure. The stations and measuring cells are temperature-controlled by one Dewar. Thus, the 3P sync enables the highest sample throughput with the smallest possible space requirement and minimum liquid nitrogen consumption. Depending on the sample volume, it can be equipped individually as a 1-, 2-, 3- or 4-station instrument. In addition, the number of pressure transducers can be configured at the measuring station. If the instrument is to be equipped with the fastest possible measuring configuration, a separate pressure sensor can be integrated in each of the four measuring stations. If the measuring speed is not relevant (e.g., for measurements overnight), the measuring instrument can be equipped with only one pressure sensor for up to four measuring stations. Depending on the price/performance ratio, less than six pressure sensors can be integrated, resulting in seven different 3P sync model configurations.

Applicable methods and determinable parameters

- Isothermal adsorption and desorption curve
- BET specific surface area (single point, multi-point)
- Langmuir surface area
- External surface area (STSA)
- BJH pore size analysis
- t-plot analysis
- DR, DA, MP method
- HK pore size analysis
- SF pore size analysis
- NLDFT pore size distribution
- Pore size mode, average pore size, total pore volume
- Calculation of heat of adsorption, etc.

Benefits and Features

- The 3P sync series is available with up to four **measurement station(s)** for high resolution sorption measurement(s).
- **Three step evacuation routine** for safe sample handling including very fine particles and highly porous materials (Figure 1).
- Each measurement station has **its own pressure transducer** (optional) and each includes its own 1000 Torr p_0 transducer (Figure 2).
- Presentation of **real-time kinetic data (pressure versus time)** to check and visualize equilibrium conditions (Figure 3).
- **Two step filter system** to protect the system against sample contamination.
- Change of dose amounts and equilibration settings **on-the-fly**, a restart of the analysis is not necessary (Figure 4).

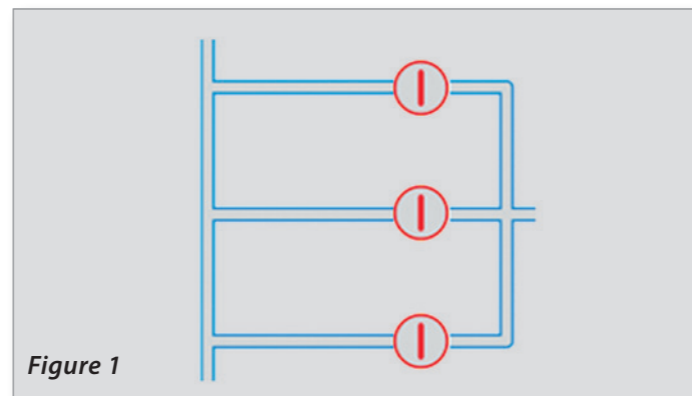

Figure 1

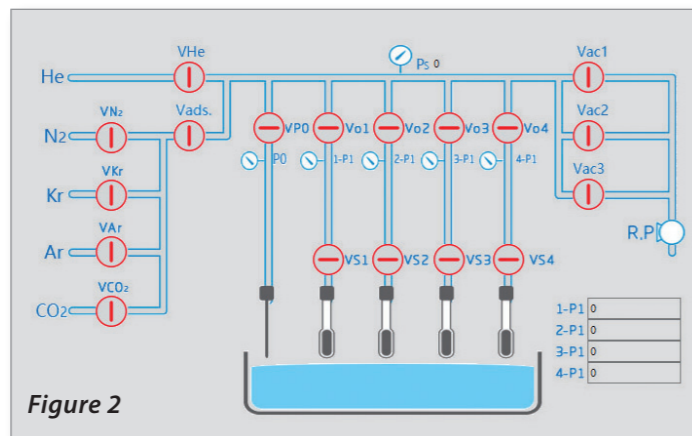

Figure 2

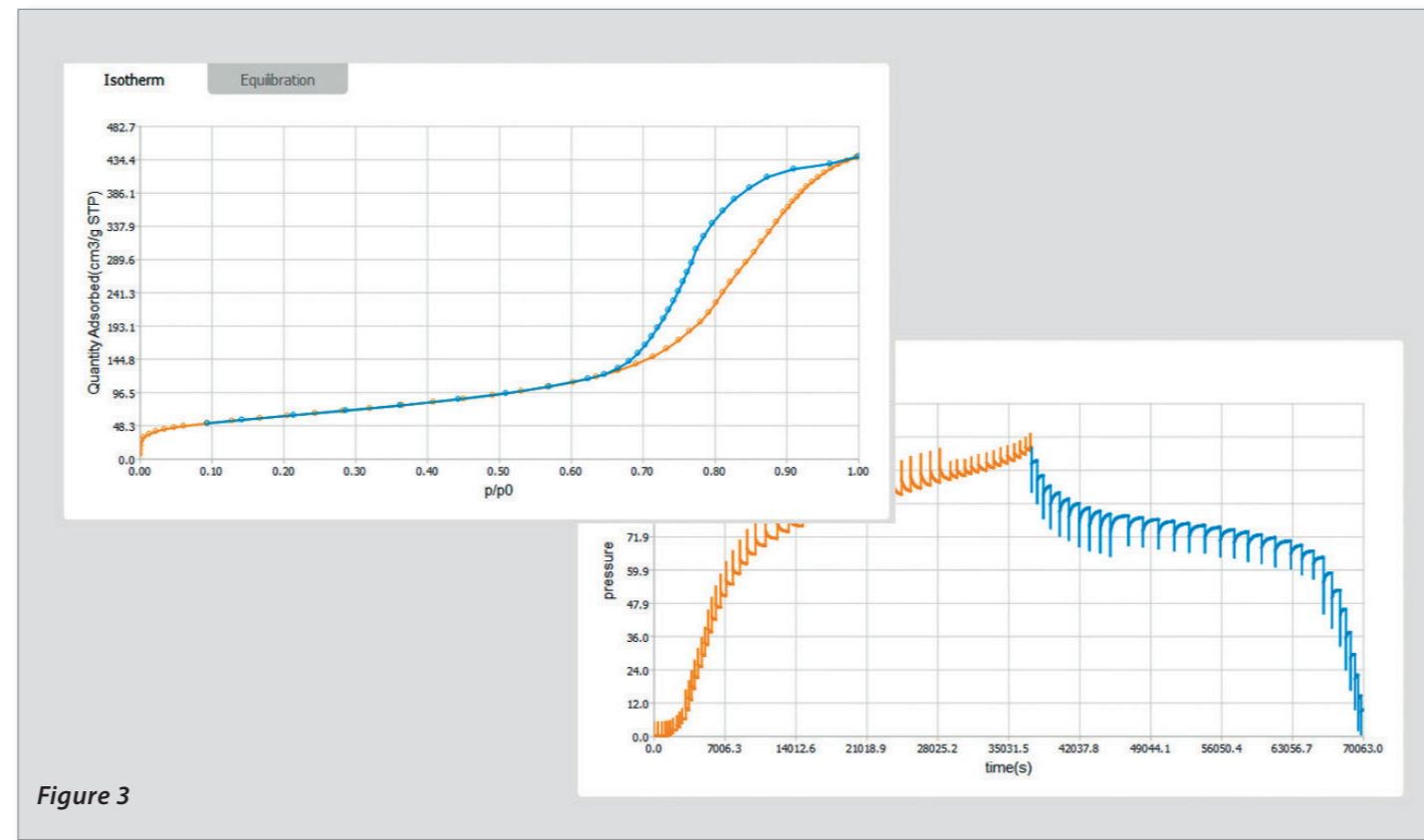

Figure 3

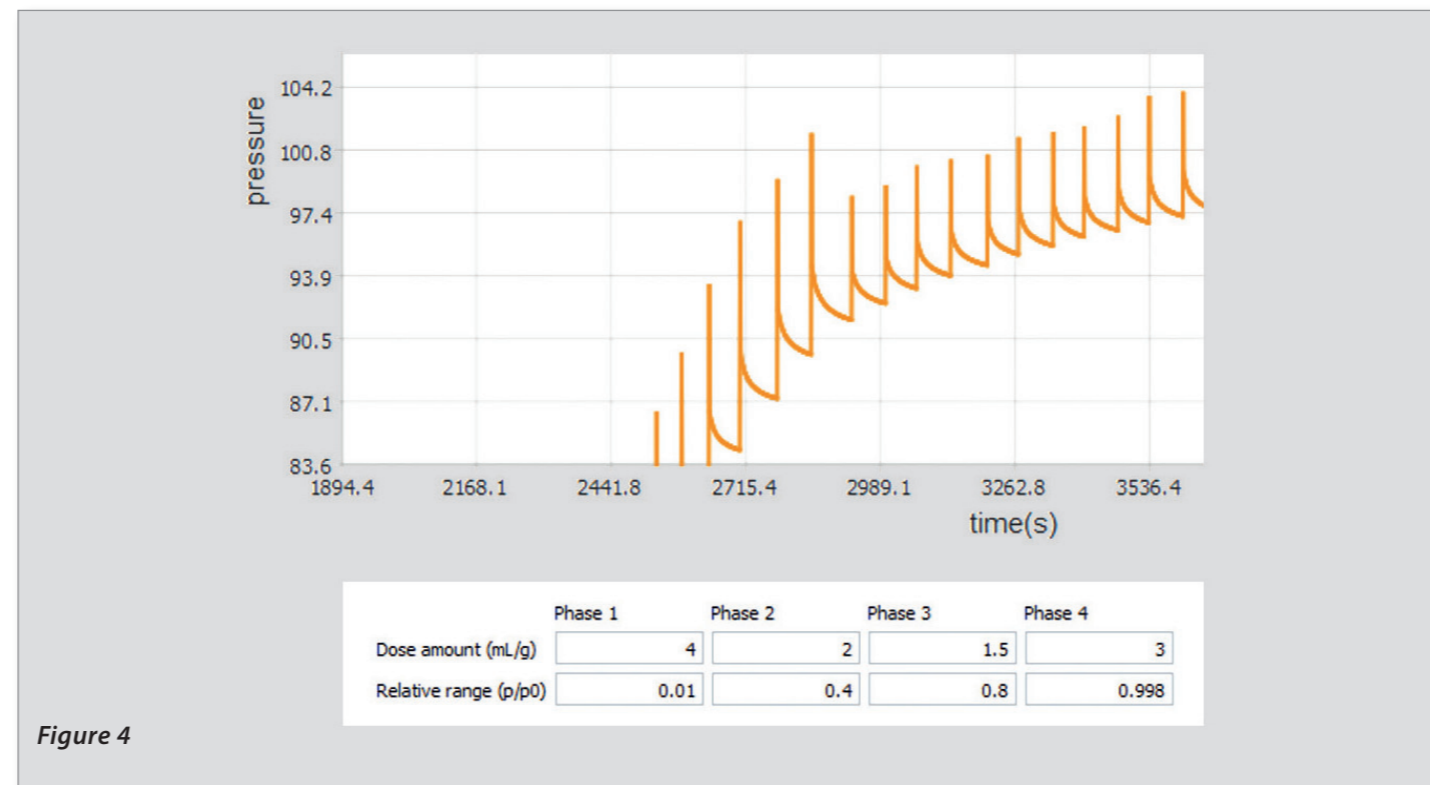

Figure 4

Specifications

Model	440	420	330	310	220	210	110
Test Principle	Gas adsorption by static volumetric method						
Adsorbates	N ₂ , Ar, Kr, H ₂ , O ₂ , CO ₂ , CO, NH ₃ , CH ₄ , etc.						
Analysis ports	4	4	3	3	2	2	1
Analysis pressure transducers	5	3	4	2	3	2	2
p_0 Transducer	1	1	1	1	1	1	1
Surface Area Range	0.0005 m ² /g to unknown upper limit; Standard sample repeat accuracy ≤ ± 1.0 %						
Pore Size Range	0.35 nm – 500 nm						
Minimum Pore Volume	0.0001 cm ³ /g						
Pressure Sensor Accuracy	± 0.15 % (Full Scale)						
Range of Relative Pressure p/p_0	10 ⁻⁴ – 0.998						
Vacuum System	Mechanical vacuum pump (ultimate vacuum 6.7*10 ⁻² Pa)						
Dimensions	L 500 x W 500 x H 800 mm						
Weight	ca. 60 kg						
Temperature Requirements of Environment	15 – 40 °C						
Humidity Requirements of Environment	10 % – 90 %						
Power Requirements	AC 220 V ± 20 V, 50/60 Hz, maximum power 300 W, current 5 A						

3P surface



With the 3P surface DX, 3P Instruments offers a fully automated dynamic single- and multi-point sorption analyzer. The dynamic flow method is still in use, especially in areas, e.g., in quality control where fast analysis times and easy handling are the main focus. The dynamic flow method is applicable if the static volumetric method does not supply valid analysis data for a variety of reasons. Pharmaceutical products, raw materials for food or metal hydroxides and materials with crystal water inclusions are examples for the latter. The new 3P surface DX may handle up to four samples and combines the advantages of the dynamic method with a high degree of automation as found in the volumetric method.

Benefits and Features

- Easy and intuitive MS Windows software for operation, calculation and data storage
- Very high reproducibility (Figure 1)
- Fully automated with four analysis stations for high throughput flow single and multipoint BET analysis (Figure 2)
- Automatic dewar lifting
- Adsorption equilibrium conditions are determined automatically
- Automatic adjustment of zeroing of thermal conductivity detector
- Reference mode for fast surface analysis

Applicable methods and determinable parameters

- Isothermal adsorbed amount
- Single-point BET
- Multi-point BET
- Reference mode (direct comparison with a certified reference)

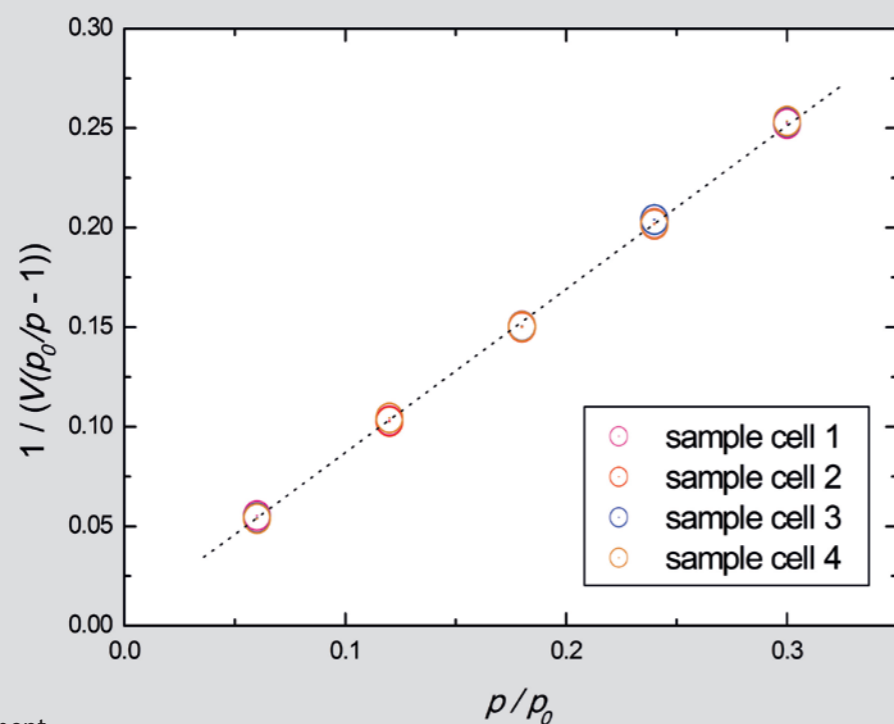
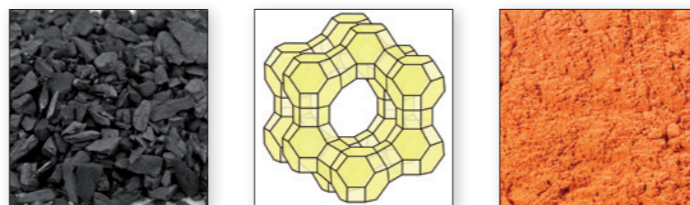

Figure 1
5-point BET measurement carried out with 3P surface DX

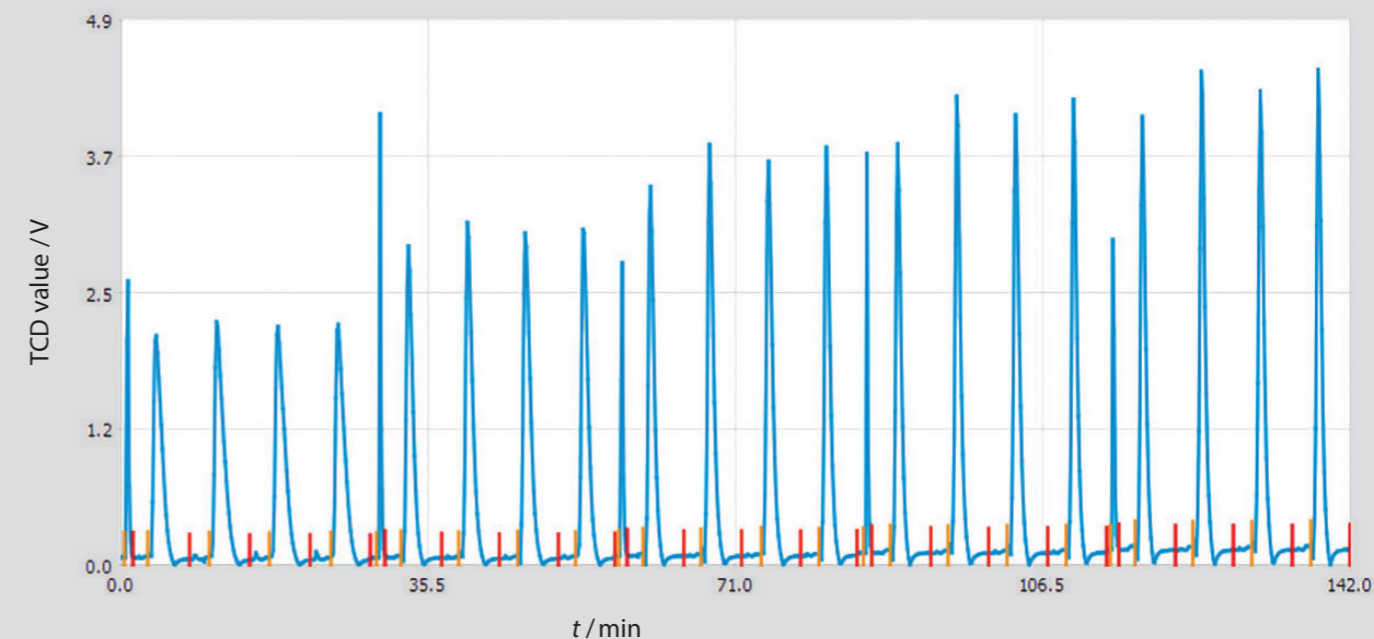

Figure 2
TCD (thermal conductivity detector) value vs. measurement time

Specifications

Measurement range (p/p_0)	0.05 – 0.3
Analysis Stations	4
Reproducibility	$\pm 1\%$
Lower Limit	0.01 m ² /g
Upper Limit	No upper limit
Speed single point BET	< 5 min
Speed multipoint BET	< 25 min
Degasser Temperature	400 °C (external)
Humidity	10 % – 90 %
Power requirements	AC 220 V \pm 20 V, 50/60 Hz, maximum power 300 W, current 5 A

Optional Accessories and Tools

Optional Accessories and Tools	3P micro	3P meso	3P sync
3P prep J4: Additional sample preparation system with 4 stations and a max. degasser temperature of 400°C. It offers an optional turbo vacuum and temperature ramp control (Figure 1).	■	■	■
Vapor source with heated manifold up to 50 °C (Figure 2).	■		
Tempering Kit for experiments from 0 to 50°C. It is most commonly used for CO ₂ , n-Butane or vapor experiments (Figure 3).	■	■	■
cryoTune series: Cryostatic accessory/temperature controller for adsorption using various adsorptives at temperatures 77–323 K. It needs only liquid nitrogen for cooling. It allows the characterization of microporous solids according to ISO 9277 and IUPAC 2015 recommendation, but also the determination of BET surface of other materials by Ar/Kr instead of N ₂ adsorption. It operates noiseless and has a very low energy consumption (Figure 4).	■	■	■
cryoCooler: Can be used for cryogen free temperature control for measurement temperatures < 20–320 K (Figure 5).	■		
Simulation software 3P sim to predict the performance of dynamic experiments or mixed gas experiments (Figure 6, right page).	■	■	■

Figure 6

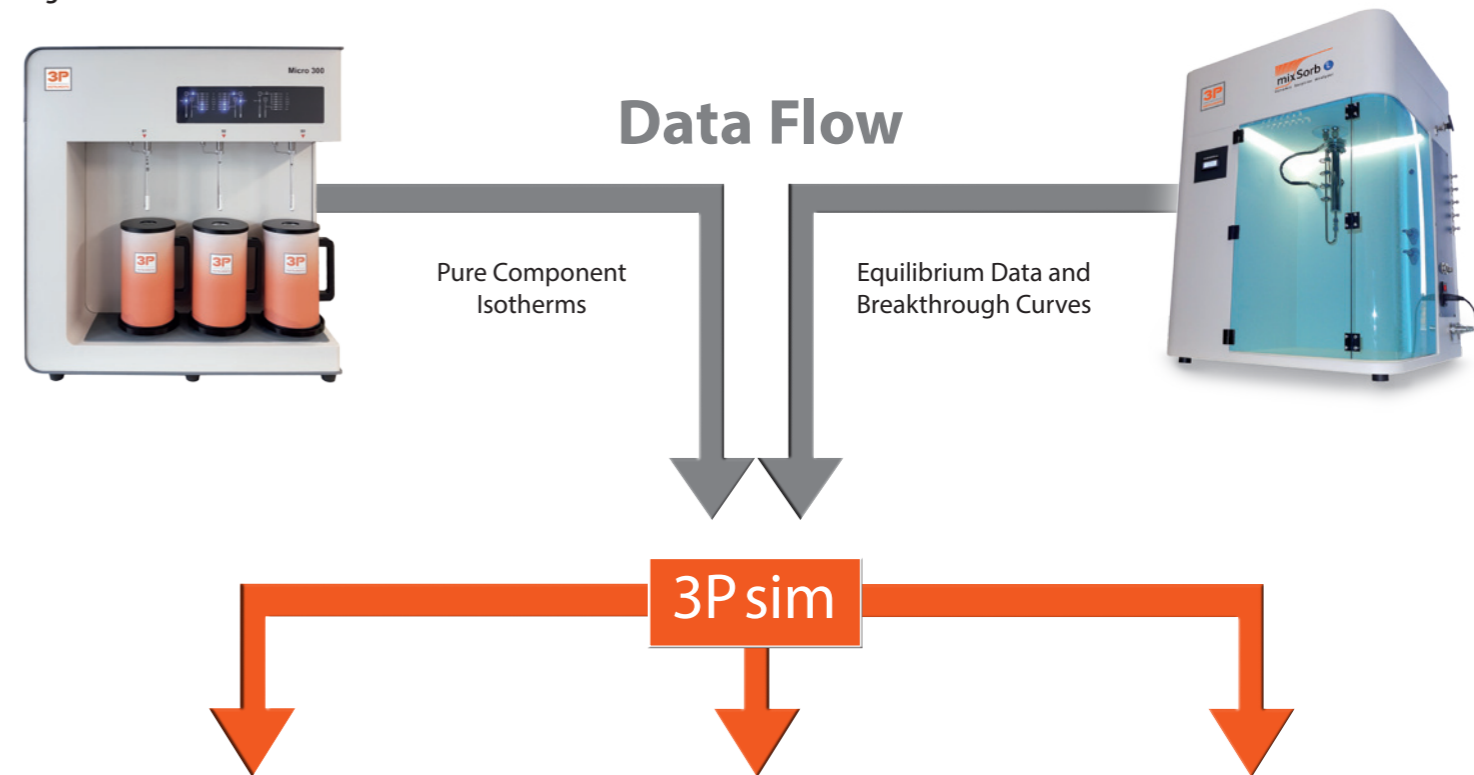

Figure 1

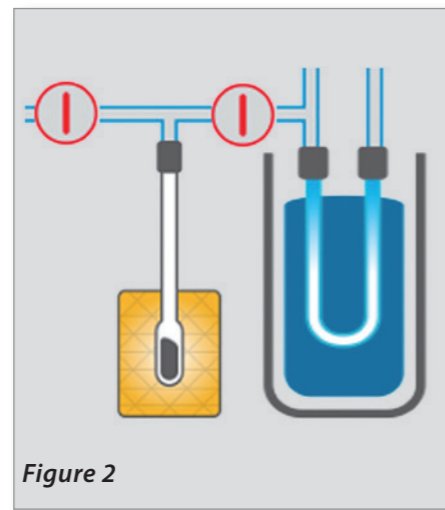

Figure 2



Figure 3



Figure 4

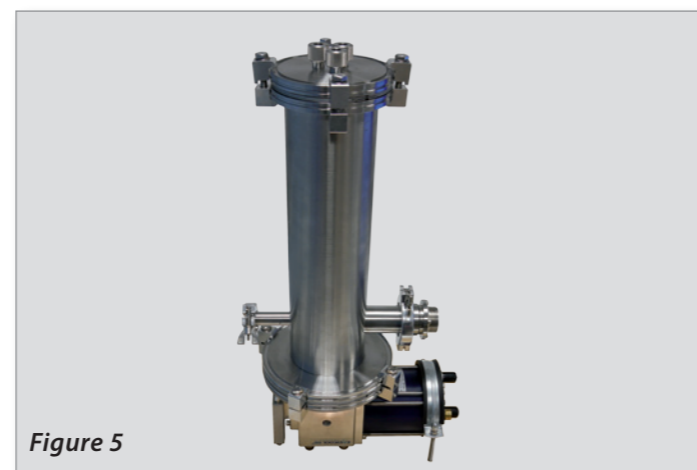

Figure 5

Isotherm Fitting

With **3P sim** measured isotherm data can be fitted with the following mathematical isotherm models:

- HENRY
- LANGMUIR
- TOTH
- SIPS
- FREUNDLICH
- DUALSITE LANGMUIR
- DUALSITE LANGMUIR SIPS

Prediction of Mixture Equilibria

The program allows the calculation of total and partial loadings at given pressures or compositions and supports the following theories:

- IAST* with LANGMUIR
- IAST with TOTH
- IAST with DUALSITE LANGMUIR
- IAST with DUALS. LANGMUIR SIPS
- Multicomponent LANGMUIR
- Multicomponent SIPS

* Ideal Adsorption Solution Theory

Dynamic Simulation

- **3P sim** provides solutions for mass- and energy balances which allow simulations without user precognition or programming skills.
- Technically relevant transport parameters (e.g., LDF* constants) are accessible
- Simulation of breakthrough curves and temperature profiles

* Linear Driving Force

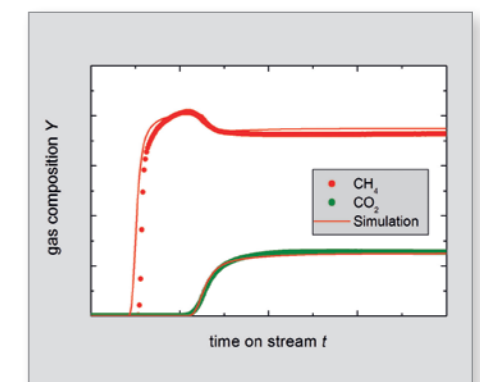
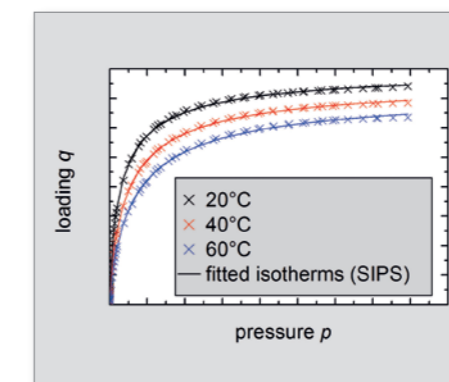
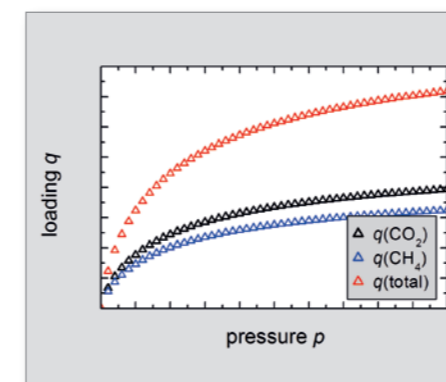

mixSorb series



For mixed gas/vapor adsorption, we offer the mixSorb series.

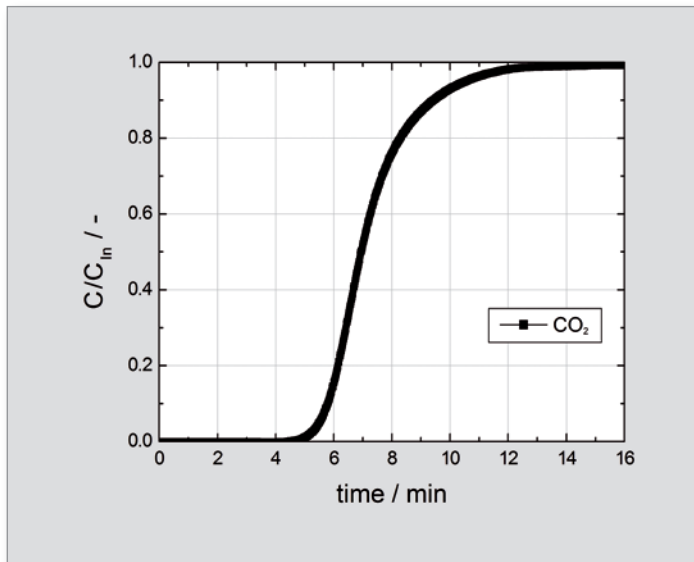

Breakthrough curve of 5 % CO₂ in N₂ on 0.5 g activated carbon at 5 bar (total flow rate 20 ml (STP) / min) measured by mixSorb SHP.

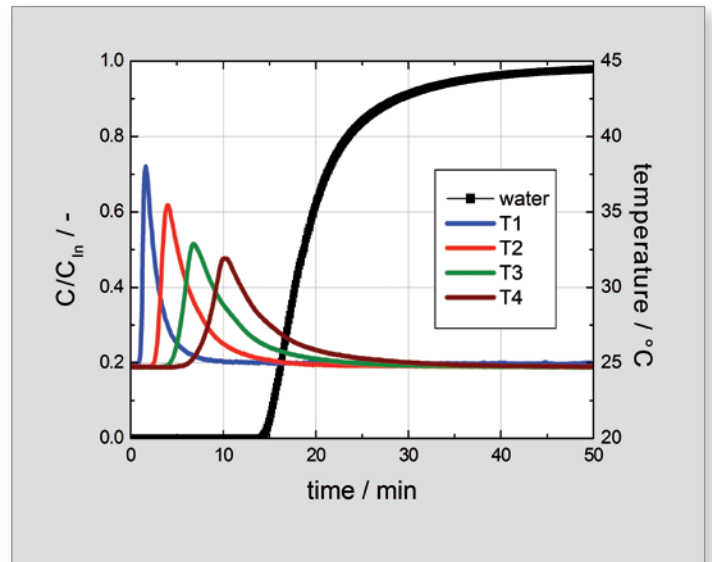

Breakthrough curve of water on 80 g activated carbon (30 % RH at 25 °C in N₂, gas flow 4000 ml (STP) / min) measured by mixSorb L.

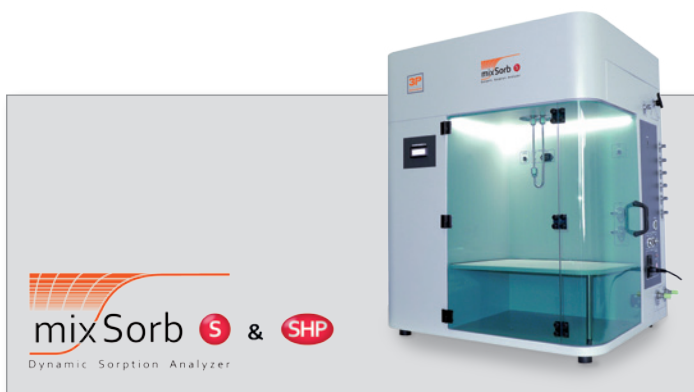

Small amounts of sample/powder (~ 1 ml)
Basic research

For Institutes for basic research and R&D of powders

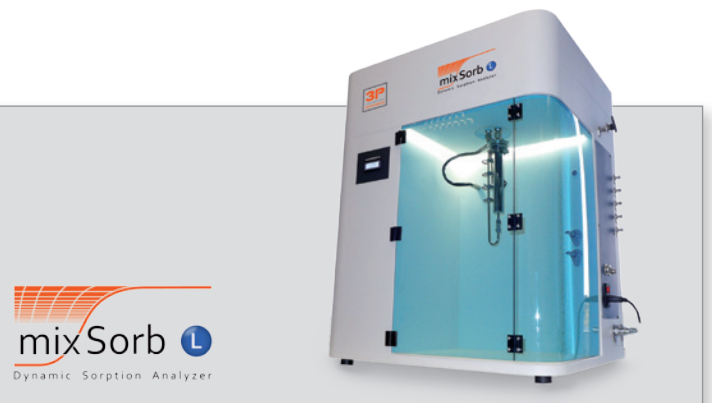

Large amounts of sample/granulate (~ 130 ml)
Application-oriented measurements

For companies/producers and institutes of applied sciences

More information:

www.dynamicsorption.com

YOUR PARTNER IN PARTICLE CHARACTERIZATION

3P INSTRUMENTS offers profound expertise for the characterization of particles, powders and pores in Europe.



The LabSPA – Laboratory for Scientific Particle Analysis – offers a broad spectrum of contract analysis for the characterization of dispersions, powders and porous materials.

Contract analysis can be carried out as single analysis, on-demand analysis for a number of samples over a predetermined frame of time or as a large scale laboratory project. We will gladly offer quotations.

Individual sample preparation and/or specific measurements can be coordinated together with our highly trained laboratory personnel.

More information: <https://www.3p-instruments.com/contract-analyses/>



Characterization of
particles • powders • pores

Tel. +49 8134 9324 0
info@3P-instruments.com

www.3P-instruments.com